

# NIO-4RNDC

## 4" Iolite Round Reflector with Round Aperture

Source: 14W to 28W LED  
800lm to 2500lm

Type

Project

Catalog No.

Notes

### PRODUCT DESCRIPTION

4" Iolite LED downlights require a dedicated Iolite new construction or remodel housing. Deep regressed cone reflectors optimize visual cut-off.

### FEATURES

- 800lm, 1000lm, 1500lm, 2000lm or 2500lm LED packages
- 2700K, 3000K, 3500K, 4000K, 5000K @ 90+ CRI
- Comfort Dim (warm dimming) also available in 800lm only
- Flood optic, narrow flood and spot optics (included)
- 5-Year limited warranty

### SPECIFICATION

**Construction:** Trims are constructed of heat dissipating, die-cast aluminum. The aluminum die-cast LED heat sink is threaded to fit the trim and transfer heat.

**Mounting:** Luminaire includes friction blades to mount securely to housing.

### OPTICS

**800-1000lm:** Three field changeable optics (spot, narrow flood and flood) are included with each LED module. Premium 10° TIR narrow spot optic assembly also available ([Click Here](#) for more information). Optional frosted and TIR optics are also available.

**1500-2500lm:** Three field changeable TIR optics (spot, narrow flood and flood) are included with each LED module.

### ELECTRICAL

**Lumens / Wattage:** 800lm / 14W, 1000lm / 14W, 1500lm / 20W, 2000lm / 24W, 2500lm / 28W

**Color Temperature:** 2700K, 3000K, 3500K, 4000K, 5000K

**Color Rendering Index:** 90+CRI

**Operating Temperature:** Specified by housing

**Lifetime:** 50,000 hours @ L70

**Comfort Dim:** Comfort Dim color tunes the temperature from a bright 3100K, to a romantic and comfortable 2000K on a gradual, even curve. Available in 800lm only.

**Dimming:** Specified by housing

### COMPATIBLE HOUSINGS

Luminaires are compatible with respective Iolite housings manufactured by Nora Lighting.

CATALOG NO.	DESCRIPTION	LUMENS / WATTAGE
<a href="#">NHIOICD-48</a>	ICAT New Construction	800-1000lm / 14W
<a href="#">NHIOICDCP-48</a>	Chicago Plenum	800-1000lm / 14W
<a href="#">NHRIOIC-48</a>	ICAT Remodel	800-1000lm / 14W
<a href="#">NHIOICD-415</a>	ICAT New Construction	1500lm / 20W
<a href="#">NHIOICDCP-415</a>	Chicago Plenum	1500lm / 20W
<a href="#">NHIOICD-420</a>	ICAT New Construction	2000lm / 24W
<a href="#">NHIOICDCP-420</a>	Chicago Plenum	2000lm / 24W
<a href="#">NHIOICD-425</a>	ICAT New Construction	2500lm / 28W
<a href="#">NHIOICDCP-425</a>	Chicago Plenum	2500lm / 28W

**Accessories:** Luminaires can accommodate (1) hex louver and (1) translucent deco collar or opaque snoot, no accessory holder is required, see accessories page. Flush mount mud ring is available to give the appearance of a trimless, compatible with new construction housing only.

### LABELS AND LISTINGS

- cULus Listed for Wet Locations
- ENERGY STAR certified
- [5-Year Limited Warranty](#)
- RoHS Compliant
- Certified to the high efficacy requirements of California Title 24 JA8-2022



### PRODUCT IMAGES & DIMENSIONS

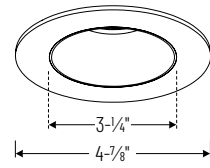

**NIO-4RNDC**  
Round Reflector with Round Aperture  
Non-Adjustable



**BB**  
Black Reflector  
Black Flange



**BW**  
Black Reflector  
White Flange

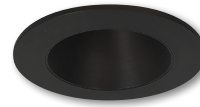

**BZ**  
Bronze Reflector  
Bronze Flange

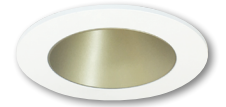

**CHMPW**  
Champagne Haze Reflector  
Matte Powder White Flange



**CMPW**  
Specular Clear Reflector  
Matte Powder White Flange



**HW**  
Haze Reflector  
White Flange



**HZMPW**  
Haze Reflector  
Matte Powder White Flange



**MPW**  
Matte Powder White Reflector  
Matte Powder White Flange



**NN**  
Natural Metal Reflector  
Natural Metal Flange



**WW**  
White Reflector  
White Flange

### 4" Iolite Round Reflector with Round Aperture - Dedicated Housing Required

Color Temperature	Finish	Lumens / Wattage
<b>NIO-4RNDC50X</b> = 5000K*	<b>BB</b> = Black / Black	(blank) = 800lm / 14W
<b>NIO-4RNDCDXX</b> = Comfort Dim†	<b>BW</b> = Black / White	
<b>NIO-4RNDC27X</b> = 2700K	<b>BZ</b> = Bronze / Bronze	<b>/I0</b> = 1000lm / 14W
<b>NIO-4RNDC30X</b> = 3000K	<b>CHMPW</b> = Champagne / Matte Powder White	<b>/HL</b> = 1500-2500lm (varies by housing)
<b>NIO-4RNDC35X</b> = 3500K	<b>CMPW</b> = Specular Clear / Matte Powder White	
<b>NIO-4RNDC40X</b> = 4000K	<b>HW</b> = Haze / White	
<b>NIO-4RNDC50X</b> = 5000K	<b>HZMPW</b> = Haze / Matte Powder White	
	<b>MPW</b> = Matte Powder White	
	<b>NN</b> = Natural Metal / Natural Metal	
	<b>WW</b> = White / White	

\* 5000K LED modules in 800lm are while supplies last

† Comfort Dim available in 800lm only and 1" Iolite uses a different dimming curve than 2" & 4" Iolite

### Compatible Housings

Housing Type
<b>NHIOICD-48</b> = ICAT New Construction / 800-1000lm / 14W
<b>NHIOICDCP-48</b> = Chicago Plenum / 800-1000lm / 14W
<b>NHRIOIC-48</b> = ICAT Remodel / 800-1000lm / 14W
<b>NHIOICD-415</b> = ICAT New Construction / 1500lm / 20W
<b>NHIOICDCP-415</b> = Chicago Plenum / 1500lm / 20W
<b>NHIOICD-420</b> = ICAT New Construction / 2000lm / 24W
<b>NHIOICDCP-420</b> = Chicago Plenum / 2000lm / 24W
<b>NHIOICD-425</b> = ICAT New Construction / 2500lm / 28W
<b>NHIOICDCP-425</b> = Chicago Plenum / 2500lm / 28W

Example: **NIO-4RNDC50XWW** = 4" Iolite Round Reflector with Round Aperture, 5000K, White finish, 800lm

# 4" Iolite Accessories

## 4" Iolite Round Reflector with Round Aperture

Type
Project
Catalog No.
Notes

### FIELD CHANGEABLE OPTICS

Iolite luminaires include spot, narrow flood and flood optics. Optics can be changed in the field by removing LED module from die-cast trim. Optional frosted and TIR optics are also available.

**Note:** Frosted and Premium TIR optics are not compatible with /HL LED modules.

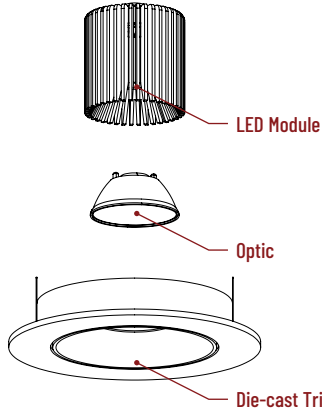

#### Frosted Optics

**NIO-REFL38FR** 60° Optic  
**NIO-REFL60FR** 73° Optic  
 Not compatible with /HL LED module.

#### Premium TIR Optics

**NIO-REFLTIR15** 22° Optic  
**NIO-REFLTIR25** 26° Optic  
 Not compatible with /HL, Comfort Dim (CDX) LED modules or Hex Cell Louver.

#### 10° TIR Optic Assembly

Specialized narrow spot LED module assembly is also available. Requires LE4 housing. [Click Here](#) for more information.

### ACCESSORIES

Iolite accessories can be added at any point in the design process. Accessories easily install between LED module and die-cast trim.

Luminaire will accommodate (1) hex louver and (1) collar accessory, no accessory holder required.

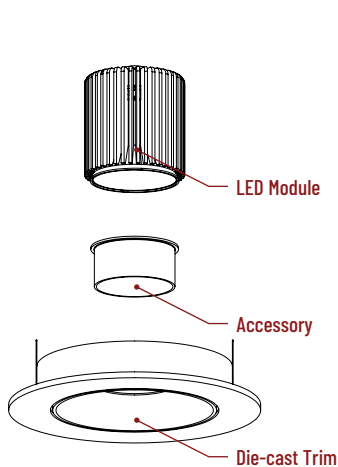

#### Translucent Decorative Collar

**NIO-AS14(color)** 5/8" length  
**NIO-AS19(color)** 3/4" length  
**NIO-AS26(color)** 1" length  
**Color:** AM (amber), BLU (blue), FR (frosted), R (red)

Translucent collars color the aperture with the specified color while producing white general light. Collars are available in different lengths. Use to add interest, create a theme, match a theme or define a space.

#### Opaque Collar Snoot

**NIO-AS14(color)** 5/8" length  
**NIO-AS19(color)** 3/4" length  
**NIO-AS26(color)** 1" length  
**Color:** MPW (matte powder white), WH (white)

Opaque snoot greatly reduces aperture brightness while preserving light output.

#### Hex Cell Louver

**NIO-HC** Black  
 Hex cell louver subtly reduces aperture brightness by reducing light output by about 20%.

**Hex cell louver is not compatible with TIR optics.**

### FLUSH MOUNT

4" Iolite trims can be installed flush with the drywall for a flush mount appearance. A flush mount mud ring is installed after the drywall and a professional drywall finisher floats the ceiling to blend in the mud ring.

#### Flush Mount Mud Ring

**NIO-FMMR-4R** Round Mud Ring

Mounts reflector flush to ceiling with flange visible. Mud ring attaches to drywall. **Only for use with NHIOICD-48 or NHIOICDCP-48 new construction housings and NIO-4R trims.** Dimensions: 7-7/8" diameter 1/2" thick



# PHOTOMETRICS

4" Iolite Round Reflector with Round Aperture  
1000 lumens

Type

Project

Catalog No.

Notes

## Test Information

Test Number: NTR2222R2  
Part Number: NIO-4RNDC30XWW/10  
Beam Spread: 27° Spot  
Lumens: 1114lm  
Wattage: 13.65W  
Efficacy: 82lpw  
CCT / CRI: 3000K / 90 CRI  
Spacing Criteria (0°-180°): 0.46  
Spacing Criteria (90°-270°): 0.46

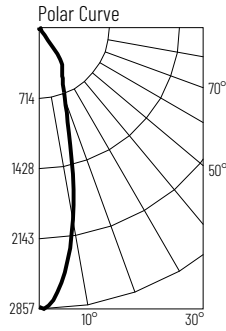

## Illuminance at a Distance

Distance from Luminaire	FC at Nadir	Beam Diameter
4'	179fc	1'-11"
6'	79.4fc	2'-11"
8'	44.6fc	3'-11"
10'	28.6fc	4'-10"
12'	19.8fc	5'-8"

## Zonal Lumen Summary

Zone	Lumens	% Luminaire
0-30	850	76.3
0-40	1026	92.1
0-60	1092	98.1
0-90	1114	100
90-180	0	0
0-180	1114	100

## Candela Table

Vertical Angles	Candela
0	2857
5	2583
15	1231
25	590
35	323
45	52

## Test Information

Test Number: NTR2223R2  
Part Number: NIO-4RNDC30XWW/10  
Beam Spread: 43° Narrow Flood  
Lumens: 1122lm  
Wattage: 13.65W  
Efficacy: 82lpw  
CCT / CRI: 3000K / 90 CRI  
Spacing Criteria (0°-180°): 0.7  
Spacing Criteria (90°-270°): 0.7

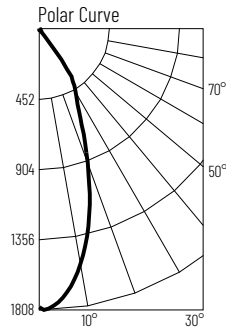

## Illuminance at a Distance

Distance from Luminaire	FC at Nadir	Beam Diameter
4'	113fc	3'-2"
6'	50.2fc	4'-8"
8'	28.2fc	6'-4"
10'	18.1fc	7'-11"
12'	12.6fc	9'-6"

## Zonal Lumen Summary

Zone	Lumens	% Luminaire
0-30	849	75.7
0-40	1028	91.7
0-60	1098	97.9
0-90	1122	100
90-180	0	0
0-180	1122	100

## Candela Table

Vertical Angles	Candela
0	1808
5	1737
15	1341
25	676
35	290
45	49

## Test Information

Test Number: NTR2224R2  
Part Number: NIO-4RNDC30XWW/10  
Beam Spread: 59° Flood  
Lumens: 1115lm  
Wattage: 13.65W  
Efficacy: 82lpw  
CCT / CRI: 3000K / 90 CRI  
Spacing Criteria (0°-180°): 0.9  
Spacing Criteria (90°-270°): 0.9

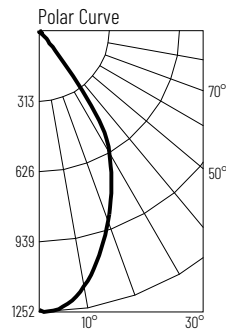

## Illuminance at a Distance

Distance from Luminaire	FC at Nadir	Beam Diameter
4'	78.3fc	4'-6"
6'	34.8fc	6'-8"
8'	19.6fc	9'
10'	12.5fc	11'-2"
12'	8.7fc	13'-6"

## Zonal Lumen Summary

Zone	Lumens	% Luminaire
0-30	773	69.3
0-40	1008	90.4
0-60	1089	97.6
0-90	1115	100
90-180	0	0
0-180	1115	100

## Candela Table

Vertical Angles	Candela
0	1252
5	1233
15	1095
25	786
35	393
45	60

## Lumen Output Multipliers

Color Temperature: 2700K (0.98), 3000K (1.00), 3500K (1.09), 4000K (1.19), 5000K (1.16)

# PHOTOMETRICS

## 4" Iolite Round Reflector with Round Aperture 1500 lumens

Type

Project

Catalog No.

Notes

### Test Information

Test Number: NTR1659R1  
Part Number: N10-4RNDC30XWW/HL  
Beam Spread: 42° Spot  
Lumens: 1744lm  
Wattage: 19.4W  
Efficacy: 90lpw  
CCT / CRI: 3000K / 90 CRI  
Spacing Criteria (0°-180°): 0.7  
Spacing Criteria (90°-270°): 0.7

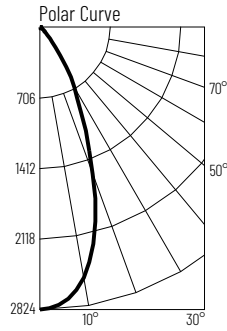

### Illuminance at a Distance

Distance from Luminaire	FC at Nadir	Beam Diameter
6'	78.4fc	4'-8"
8'	44.1fc	6'-4"
10'	28.2fc	7'-10"
12'	19.6fc	9'-5"
14'	14.4fc	10'-11"

### Zonal Lumen Summary

Zone	Lumens	% Luminaire
0-30	1318	75.5
0-40	1574	90.3
0-60	1698	97.3
0-90	1733	99.4
90-180	11	0.6
0-180	1744	100

### Candela Table

Vertical Angles	Candela
0	2824
5	2755
15	2126
25	1043
35	417
45	100

### Test Information

Test Number: NTR1661R1  
Part Number: N10-4RNDC30XWW/HL  
Beam Spread: 54° Narrow Flood  
Lumens: 1915lm  
Wattage: 19.4W  
Efficacy: 99lpw  
CCT / CRI: 3000K / 90 CRI  
Spacing Criteria (0°-180°): 0.88  
Spacing Criteria (90°-270°): 0.86

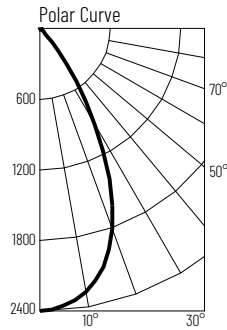

### Illuminance at a Distance

Distance from Luminaire	FC at Nadir	Beam Diameter
6'	66.7fc	6'-1"
8'	37.5fc	8'-2"
10'	24fc	10'-2"
12'	16.7fc	12'-4"
14'	12.2fc	14'-4"

### Zonal Lumen Summary

Zone	Lumens	% Luminaire
0-30	1422	74.3
0-40	1765	92.1
0-60	1879	98.1
0-90	1903	99.4
90-180	12	0.6
0-180	1915	100

### Candela Table

Vertical Angles	Candela
0	2400
5	2365
15	2095
25	1408
35	547
45	86

### Test Information

Test Number: NTR1663R1  
Part Number: N10-4RNDC30XWW/HL  
Beam Spread: 66° Flood  
Lumens: 1591lm  
Wattage: 19.26W  
Efficacy: 83lpw  
CCT / CRI: 3000K / 90 CRI  
Spacing Criteria (0°-180°): 1.02  
Spacing Criteria (90°-270°): 1.02

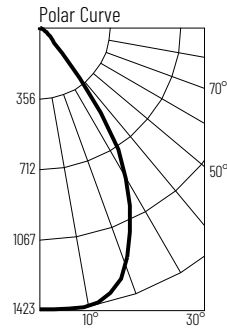

### Illuminance at a Distance

Distance from Luminaire	FC at Nadir	Beam Diameter
6'	39.4fc	7'-10"
8'	22.1fc	10'-6"
10'	14.2fc	13'-1"
12'	9.8fc	15'-8"
14'	7.2fc	18'-4"

### Zonal Lumen Summary

Zone	Lumens	% Luminaire
0-30	1016	63.9
0-40	1354	85.1
0-60	1533	96.4
0-90	1582	99.5
90-180	9	0.6
0-180	1591	100

### Candela Table

Vertical Angles	Candela
0	1417
5	1420
15	1383
25	1083
35	594
45	104

### Lumen Output Multipliers

Color Temperature: 2700K (0.92), 3000K (1.00), 3500K (1.1), 4000K (1.12), 5000K (1.18)

# PHOTOMETRICS

## 4" Iolite Round Reflector with Round Aperture 2000 lumens

Type

Project

Catalog No.

Notes

### Test Information

Test Number: NTR1660R1  
 Part Number: N10-4RNDC30XWW/HL  
 Beam Spread: 43° Spot  
 Lumens: 2047lm  
 Wattage: 23.38W  
 Efficacy: 88lpw  
 CCT / CRI: 3000K / 90 CRI  
 Spacing Criteria (0°-180°): 0.7  
 Spacing Criteria (90°-270°): 0.7

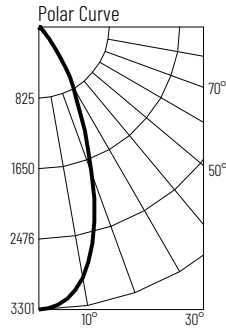

### Illuminance at a Distance

Distance from Luminaire	FC at Nadir	Beam Diameter
12'	22.9fc	9'-5"
14'	16.8fc	11'
16'	12.9fc	12'-7"
18'	10.2fc	14'-1"
20'	8.3fc	15'-8"

### Zonal Lumen Summary

Zone	Lumens	% Luminaire
0-30	1545	75.5
0-40	1847	90.3
0-60	1992	97.3
0-90	2034	99.4
90-180	13	0.6
0-180	2047	100

### Candela Table

Vertical Angles	Candela
0	3301
5	3208
15	2461
25	1248
35	481
45	117

### Test Information

Test Number: NTR1662R1  
 Part Number: N10-4RNDC30XWW/HL  
 Beam Spread: 54° Narrow Flood  
 Lumens: 2249lm  
 Wattage: 23.4W  
 Efficacy: 96lpw  
 CCT / CRI: 3000K / 90 CRI  
 Spacing Criteria (0°-180°): 0.88  
 Spacing Criteria (90°-270°): 0.86

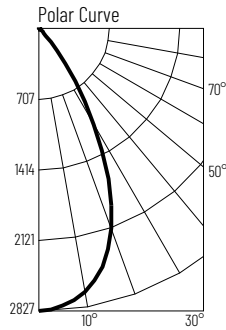

### Illuminance at a Distance

Distance from Luminaire	FC at Nadir	Beam Diameter
12'	19.6fc	12'-4"
14'	14.4fc	14'-4"
16'	11fc	16'-4"
18'	8.7fc	18'-5"
20'	7.1fc	20'-5"

### Zonal Lumen Summary

Zone	Lumens	% Luminaire
0-30	1671	74.3
0-40	2072	92.1
0-60	2206	98.1
0-90	2234	99.4
90-180	15	0.6
0-180	2249	100

### Candela Table

Vertical Angles	Candela
0	2827
5	2783
15	2473
25	1652
35	628
45	107

### Test Information

Test Number: NTR1664R1  
 Part Number: N10-4RNDC30XWW/HL  
 Beam Spread: 66° Flood  
 Lumens: 1878lm  
 Wattage: 23.43W  
 Efficacy: 80lpw  
 CCT / CRI: 3000K / 90 CRI  
 Spacing Criteria (0°-180°): 1.02  
 Spacing Criteria (90°-270°): 1.02

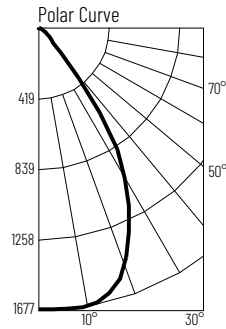

### Illuminance at a Distance

Distance from Luminaire	FC at Nadir	Beam Diameter
12'	11.6fc	15'-8"
14'	8.5fc	18'-4"
16'	6.5fc	20'-11"
18'	5.2fc	23'-6"
20'	4.2fc	26'-1"

### Zonal Lumen Summary

Zone	Lumens	% Luminaire
0-30	1199	63.9
0-40	1598	85.1
0-60	1808	96.4
0-90	1867	99.5
90-180	11	0.6
0-180	1878	100

### Candela Table

Vertical Angles	Candela
0	1672
5	1675
15	1628
25	1278
35	700
45	121

### Lumen Output Multipliers

Color Temperature: 2700K (0.94), 3000K (1.00), 3500K (1.13), 4000K (1.13), 5000K (1.2)

# PHOTOMETRICS

## 4" Iolite Round Reflector with Round Aperture 2500 lumens

Type

Project

Catalog No.

Notes

### Test Information

Test Number: NTR1829R1  
Part Number: N10-4RNDC30XWW/HL  
Beam Spread: 43° Spot  
Lumens: 2430lm  
Wattage: 27.39W  
Efficacy: 89lpw  
CCT / CRI: 3000K / 90 CRI  
Spacing Criteria (0°-180°): 0.7  
Spacing Criteria (90°-270°): 0.7

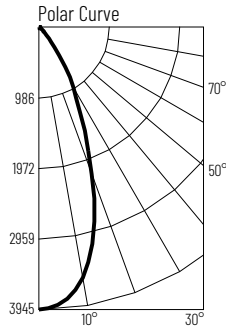

### Illuminance at a Distance

Distance from Luminaire	FC at Nadir	Beam Diameter
12'	27.3fc	9'-6"
14'	20.1fc	11'-1"
16'	15.4fc	12'-8"
18'	12.1fc	14'-4"
20'	9.8fc	15'-10"

### Zonal Lumen Summary

Zone	Lumens	% Luminaire
0-30	1859	76.5
0-40	2193	90.2
0-60	2378	97.9
0-90	2425	99.8
90-180	5	0.2
0-180	2430	100

### Candela Table

Vertical Angles	Candela
0	3934
5	3827
15	2977
25	1474
35	516
45	122

### Test Information

Test Number: NTR1830R1  
Part Number: N10-4RNDC30XWW/HL  
Beam Spread: 54° Narrow Flood  
Lumens: 2618lm  
Wattage: 27.44W  
Efficacy: 95lpw  
CCT / CRI: 3000K / 90 CRI  
Spacing Criteria (0°-180°): 0.88  
Spacing Criteria (90°-270°): 0.86

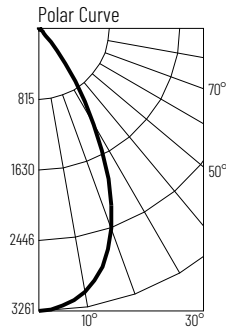

### Illuminance at a Distance

Distance from Luminaire	FC at Nadir	Beam Diameter
12'	22.6fc	12'-5"
14'	16.6fc	14'-6"
16'	12.7fc	16'-7"
18'	10.1fc	18'-7"
20'	8.2fc	20'-8"

### Zonal Lumen Summary

Zone	Lumens	% Luminaire
0-30	1945	74.3
0-40	2421	92.5
0-60	2581	98.6
0-90	2613	99.8
90-180	5	0.2
0-180	2618	100

### Candela Table

Vertical Angles	Candela
0	3259
5	3196
15	2826
25	1921
35	773
45	144

### Test Information

Test Number: NTR1831R1  
Part Number: N10-4RNDC30XWW/HL  
Beam Spread: 66° Flood  
Lumens: 2223lm  
Wattage: 27.34W  
Efficacy: 82lpw  
CCT / CRI: 3000K / 90 CRI  
Spacing Criteria (0°-180°): 1.06  
Spacing Criteria (90°-270°): 1.04

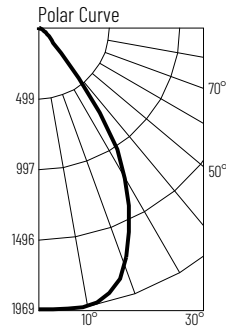

### Illuminance at a Distance

Distance from Luminaire	FC at Nadir	Beam Diameter
12'	13.7fc	14'-11"
14'	10fc	17'-5"
16'	7.7fc	19'-11"
18'	6.1fc	22'-5"
20'	4.9fc	24'-11"

### Zonal Lumen Summary

Zone	Lumens	% Luminaire
0-30	1439	64.4
0-40	1946	87.2
0-60	2160	96.8
0-90	2229	99.8
90-180	4	0.2
0-180	2232	100

### Candela Table

Vertical Angles	Candela
0	1969
5	1970
15	1951
25	1586
35	844
45	143

### Lumen Output Multipliers

Color Temperature: 2700K (0.94), 3000K (1.00), 3500K (1.13), 4000K (1.13), 5000K (1.2)

# PHOTOMETRICS

## 4" Iolite Round Reflector with Round Aperture 2500 lumens

Type

Project

Catalog No.

Notes

### Test Information

Test Number: NTR1829R1  
Part Number: N10-4RNDC30XWW/HL  
Beam Spread: 43° Spot  
Lumens: 2430lm  
Wattage: 27.39W  
Efficacy: 89lpw  
CCT / CRI: 3000K / 90 CRI  
Spacing Criteria (0°-180°): 0.7  
Spacing Criteria (90°-270°): 0.7

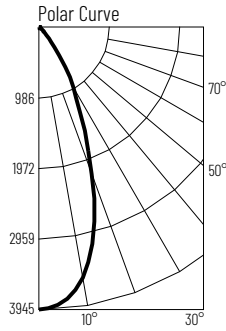

### Illuminance at a Distance

Distance from Luminaire	FC at Nadir	Beam Diameter
12'	27.3fc	9'-6"
14'	20.1fc	11'-1"
16'	15.4fc	12'-8"
18'	12.1fc	14'-4"
20'	9.8fc	15'-10"

### Zonal Lumen Summary

Zone	Lumens	% Luminaire
0-30	1859	76.5
0-40	2193	90.2
0-60	2378	97.9
0-90	2425	99.8
90-180	5	0.2
0-180	2430	100

### Candela Table

Vertical Angles	Candela
0	3934
5	3827
15	2977
25	1474
35	516
45	122

### Test Information

Test Number: NTR1830R1  
Part Number: N10-4RNDC30XWW/HL  
Beam Spread: 54° Narrow Flood  
Lumens: 2618lm  
Wattage: 27.44W  
Efficacy: 95lpw  
CCT / CRI: 3000K / 90 CRI  
Spacing Criteria (0°-180°): 0.88  
Spacing Criteria (90°-270°): 0.86

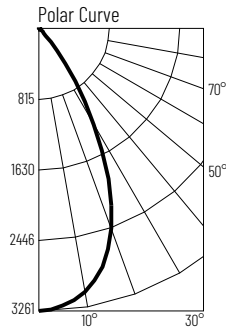

### Illuminance at a Distance

Distance from Luminaire	FC at Nadir	Beam Diameter
12'	22.6fc	12'-5"
14'	16.6fc	14'-6"
16'	12.7fc	16'-7"
18'	10.1fc	18'-7"
20'	8.2fc	20'-8"

### Zonal Lumen Summary

Zone	Lumens	% Luminaire
0-30	1945	74.3
0-40	2421	92.5
0-60	2581	98.6
0-90	2613	99.8
90-180	5	0.2
0-180	2618	100

### Candela Table

Vertical Angles	Candela
0	3259
5	3196
15	2826
25	1921
35	773
45	144

### Test Information

Test Number: NTR1831R1  
Part Number: N10-4RNDC30XWW/HL  
Beam Spread: 66° Flood  
Lumens: 2223lm  
Wattage: 27.34W  
Efficacy: 82lpw  
CCT / CRI: 3000K / 90 CRI  
Spacing Criteria (0°-180°): 1.06  
Spacing Criteria (90°-270°): 1.04

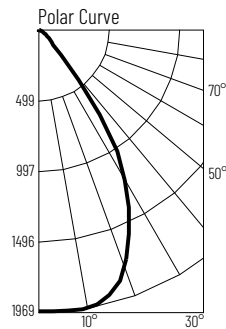

### Illuminance at a Distance

Distance from Luminaire	FC at Nadir	Beam Diameter
12'	13.7fc	14'-11"
14'	10fc	17'-5"
16'	7.7fc	19'-11"
18'	6.1fc	22'-5"
20'	4.9fc	24'-11"

### Zonal Lumen Summary

Zone	Lumens	% Luminaire
0-30	1439	64.4
0-40	1946	87.2
0-60	2160	96.8
0-90	2229	99.8
90-180	4	0.2
0-180	2232	100

### Candela Table

Vertical Angles	Candela
0	1969
5	1970
15	1951
25	1586
35	844
45	143

### Lumen Output Multipliers

Color Temperature: 2700K (0.94), 3000K (1.00), 3500K (1.13), 4000K (1.13), 5000K (1.2)